

SPECIFICATIONS

SPEC. No. CS-1050
DATE MAY. 2008

**SPECIFICATIONS
HYDRAULIC CRANE
FOR MARINE USE**

MODEL:UNIC UBV344J

Specifications subject to change without notice.

FURUKAWA UNIC CORPORATION

*EXPORT TECHNICAL DEPT
TOKYO JAPAN*

UNIC CRANE PERFORMANCE
MODEL : UBV344J

CRANE CAPACITY:

LIFTING CAPACITY : Max. 3030kg at 2.5m

**HOOK HEIGHT
ABOVE CRANE
INSTALLATION BASE LEVEL** : Max. 10.2m

WORKING RADIUS : Min 0.50m, Max. 9.81m

BOOM:

Four-section box beam type telescoping boom

Boom Length
 Retracted boom; 3.41m
 Extended boom; 10.00m
Boom Extending Speed; 6.59m / 14 s
Boom Raising Speed; 1° to 81° / 7 s

WINCH:

Hydraulic motor driven, spur gear reduction,
with automatic mechanical brake.

Single Line Pull; 7.35kN {750kgf}
Hoisting Speed
 Single line speed; 68.0m / min at 3rd layer
 Hook speed; 17.0m / min at 3rd layer with 4-part line
Hook Block; 3000kg capacity, 2 sheaves with safety latch
Wire Rope
 Construction (JIS); IWRC 6 x Fi(29) Galvanized GRADE B
 Diameter x Length; 8mm x 62m
 Breaking strength; 43.3kN {4420kgf}

SLEWING:

Hydraulic motor driven, worm gear
reduction, worm self-locking brake

Slewing Range; 360° continuous rotation on a ball bearing race
Slewing Speed; 2.5 rpm

SAFETY DEVICES:

1. Pressure relief valve for hydraulic circuit
2. Counterbalance valves for boom raising
and boom telescoping cylinders
3. Boom angle indicator with load indicator
4. Automatic mechanical brake for winch
5. Load meter
6. Overwinding alarm
7. Hook safety latch

RUST PREVENTION:

Inner and outer surfaces of structural parts : Zinc coating (excepting cylinders)
Raising Cylinder rod : Hard chromium coating with double layers
Gear cases for slewing : Zinc coating
Raising Cylinder pipe : Stainless steel
Couplings : Stainless steel
Wire ropes : Coated type
Miscellaneous parts : GEOMET finish, and other coatings
Painting : With special rust prevention paint

CONTROL VALVES:

4-valve interlocking type (with stainless steel lever)
Mount the valve and lay piping by matching the actual valve dimensions.
Take the hydraulic power source (pump, tank) out of the ship. (Prepare necessary pipes as they are not included in the valve.)

HYDRAULIC SYSTEM:

Engine	Engine with accelerator
Hydraulic Pump	
Rated pressure;	20.6MPa {210kgf/cm ² }
Rated delivery;	60 ℓ/min.
Hydraulic Valves	
Control valve;	Multiple control valve, spring centered, spool-type, with pressure relief valve
Pressure relief valve setting;	20.6MPa {210kgf/cm ² }
Counterbalance valve;	Boom raising and boom telescoping cylinders
Hydraulic Actuators	
Hydraulic motors;	Hoisting: Axial plunger type Slewing: trochoid type
Hydraulic cylinders;	Double acting type 1 x Boom raising cylinder 2 x Boom telescoping cylinder

Note: When an electric motor drive system which regulates pump delivery constant is employed, set the rated delivery at a level less than 40 ℓ/min.

Note: The figures in relation to the speed are on the basis of no-load running at rated oil flow condition.

WORKING RANGE:

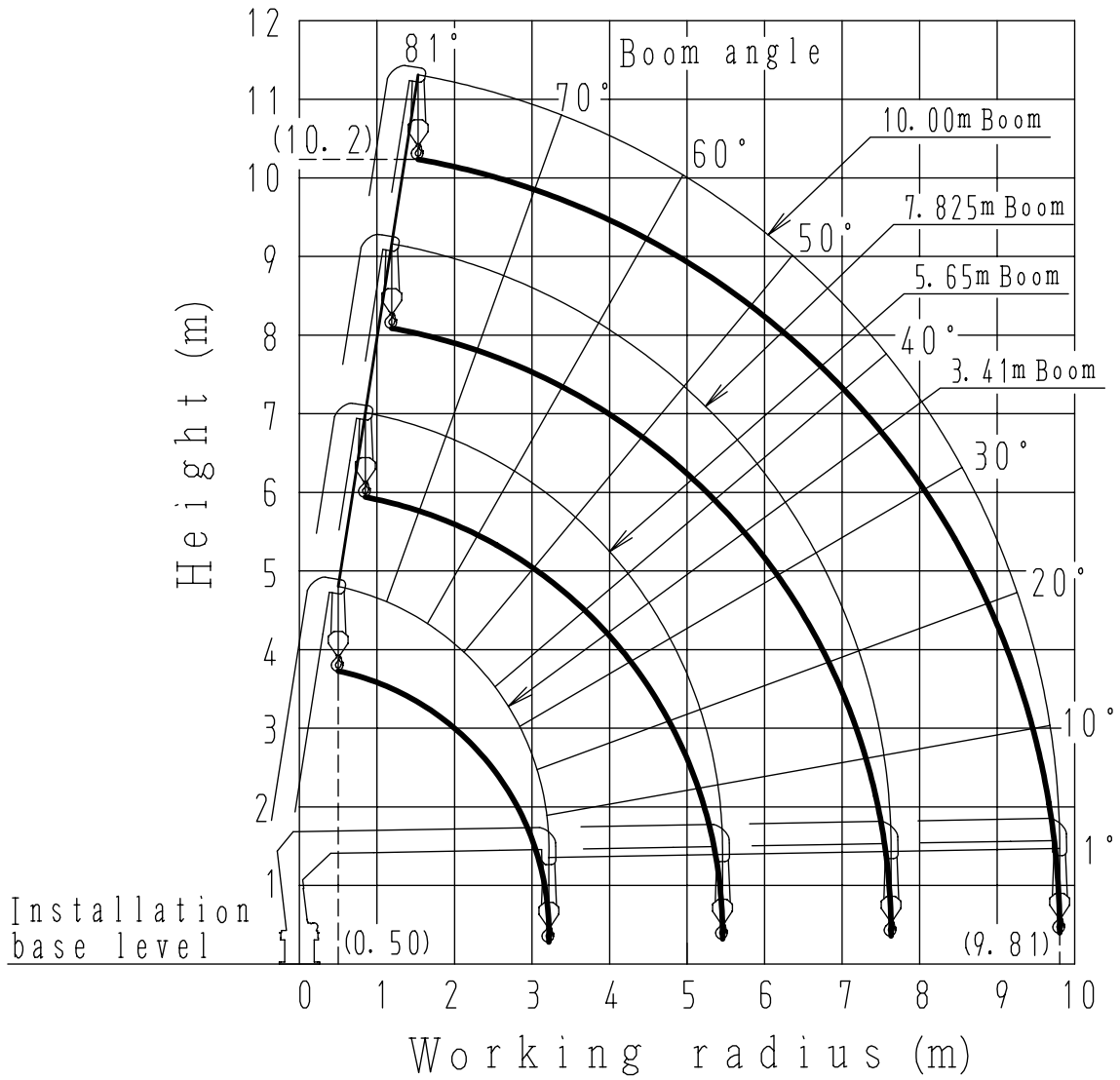

Note: The above figures are based on no-load condition and do not include the deflection of the boom.

RATED LOADS:

Unit : kg

Working Radius (m)	Boom length			
	3.41m	5.65m	7.825m	10.00m
2.0	3030	3030		
2.5	3030	3030	2330	
2.6	2930	2930	2330	
2.7	2630	2630	2330	
3.0	2330	2330	2130	
3.2	(3.22) 2130	2180	2030	
3.5		1980	1730	
4.0		1680	1430	1030
4.5		1480	1230	930
5.0		1280	1080	830
5.5		(5.46) 1180	980	780
6.0			880	730
6.5			800	680
7.0			730	630
8.0			(7.63) 680	560
9.0				500
9.81				480

() : Working radius

Note :

1. The table shows actual working radius including a possible boom deflection with a load applied when the crane has been installed horizontally.
2. Rated load is based only on the suspending strength of the crane and stability of the crane mounted ship is not considered.
Therefore, operate the crane while paying utmost attention to the stability of the ship.
3. The mass of hook(30kg), slings, and any accessories attached to the boom or loadline must be deducted from the above rated load in the chart.
4. In accordance with our policy of constant product improvement, all specifications are subject to change without notice or obligations.

TITLE		MODEL	
UNIC HYDRAULIC CRANE		UBV344J	
FOR MARINE USE		DRN	APPD
SCALE		S. ISHIBASHI N. OKOMA T. TOMIZAWA	
1/20	UNIT	DRAWING NO. B-24173	
mm	mm	DATE	
		MAY. 2008	
FURUKAWA CO., LTD.			

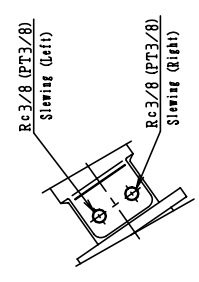

Arrow B (S=1/5)

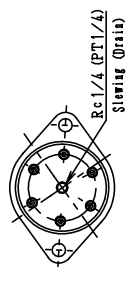

Arrow A (S=1/5)

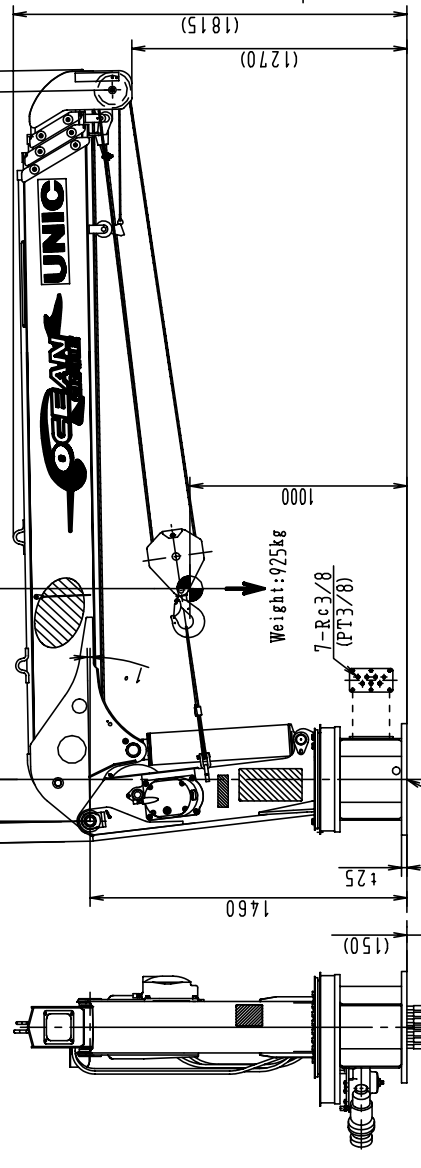
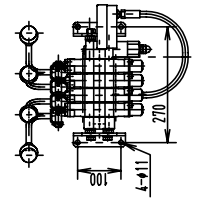
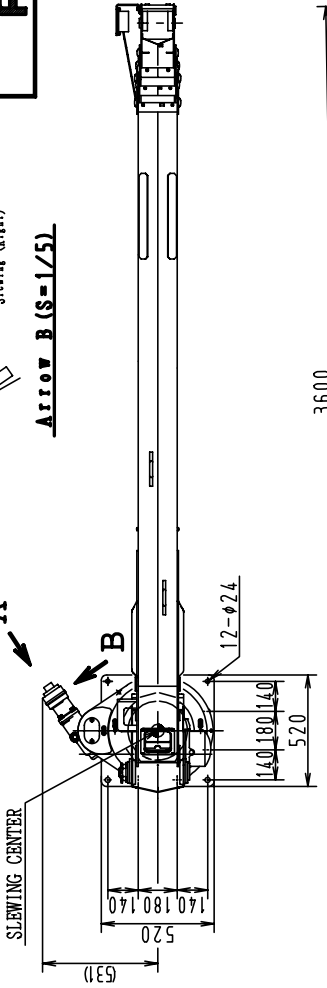

Ports for side piping

SLEWING CENTER

Hose for under piping

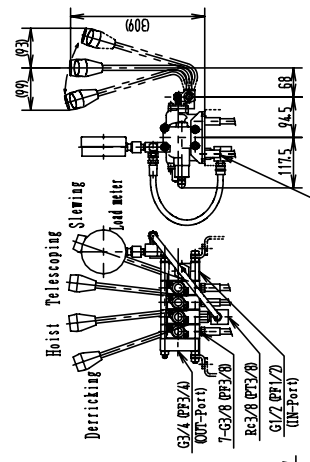

Downward ports
Control Valve (S=1/10)
Weight : 15kg